

## LEISTER Drive



LEISTER TriacDrive: Read the Triac PID or Triac S and Drive operating instructions carefully before using and keep for future reference.

### APPLICATION

LEISTER TriacDrive consists of

- Drive unit
- Hot air blower, TRIAC PID or TRIAC S
- Supporting carrier
- Pressure roller
- Overlap welding nozzle
- Guide handle

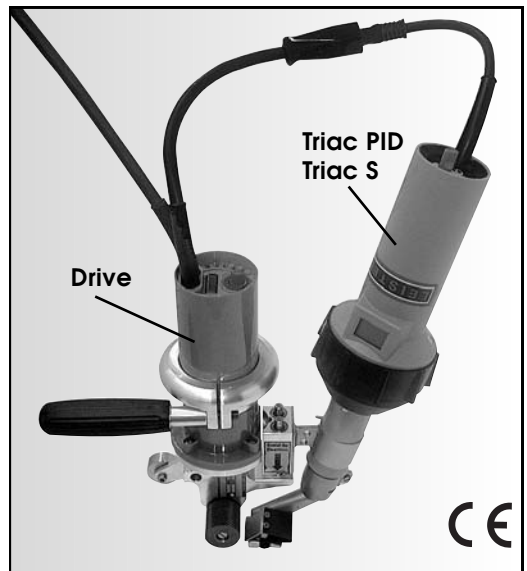

- With the drive unit, Drive, overlap welding using the compact TriacDrive tool is simplified, especially for roof and tunnel construction.
- The semi-automatic overlap welding tool, TriacDrive, is suitable for vertical and horizontal use.
- Welding of thermoplastics as well as single ply elastoplasts in the form of:
  - Geomembranes
  - Foils
  - Water bars
  - Coated fabrics



## WARNING TriacDrive



**Danger !** Unplug the tool before opening it, as live components and connections are exposed.



Incorrect use of hot air tools can present a **fire and explosion hazard**, particularly in the proximity of flammable materials and explosive gases.



**Danger of getting burned!** Do not touch the heater tube and nozzle when they are hot. Let the tool cool down. Do not point the hot air flow in the direction of people or animals.



Only connect the tool to a **receptacle with protective earth conductor**. Any disconnection of the protective earth conductor, in or outside the tool is dangerous!  
**Only use extension lead with protective earth conductor .**



## CAUTION TriacDrive



The **rated voltage** stated on the tool must correspond with the mains voltage.



For personal protection, we strongly recommend the tool to be connected to an **RCCB** (Residual Current Circuit Breaker) before using it on construction sites.



The tool must be operated **under supervision**. Heat can ignite flammable materials which are not in view.



Protect the tool from **damp and wet**.

## Approval Marks



## TECHNICAL DATA

Protection Class I



CCA certified

Type		<b>Drive</b>	
Voltage	V~	230	120
Capacity	W	100	100
Frequency	Hz	50 / 60	
Drive speed	m/min.	0.5 – 3	stepless
Dimensions	mm	250 × 165 × 88, handle ø 63	
Weight	kg	2.3 with 3 m cable	

**Mains voltage cannot be switched over!**  
For hot air blower technical data, refer to the Triac PID or Triac S operating instructions!

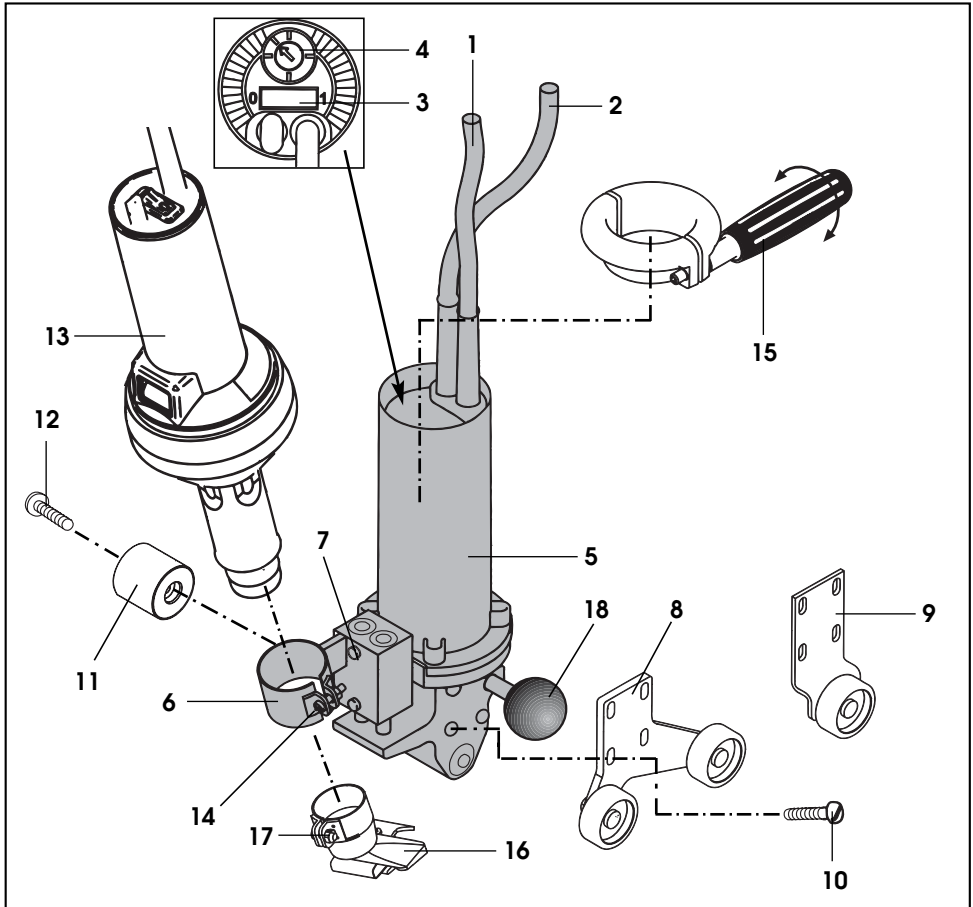

- |   |   |
|---|---|
| 1. Mains cable plug                           | 12. Fixing screw for pressure roller        |
| 2. Mains cable coupling                       | 13. Hot air blower, Triac PID or Triac S    |
| 3. Mains switch                               | 14. Fixing screw for hot air blower         |
| 4. Potentiometer for welding speed            | 15. Guide handle                            |
| 5. Drive unit                                 | 16. Overlap welding nozzle                  |
| 6. Holder for hot air blower                  | 17. Fixing screw for overlap welding nozzle |
| 7. Two adjusting screws for holder            | 18. Tool stowage bar                        |
| 8. Double supporting carrier                  |   |
| 9. Single supporting carrier                  |   |
| 10. Four fixing screws for supporting carrier |   |
| 11. Pressure roller                           |   |

**For tool description for hot air blower, refer to Triac PID or Triac S operating instructions.**

### Operating condition

- Assemble pressure roller, nozzle, handle and supporting carrier as required.
- **Assembling accessories**
  - Push **handle (15)** onto **drive unit (5)** up to the required setting. Fix **handle (15)** by turning clockwise.
  - Assemble **double supporting carrier (8)** or **single supporting carrier (9)** onto **drive unit (5)** using the four **fixing screws for supporting carrier (10)**.
  - Assemble **pressure roller (11)** using **fixing screw (12)**.
  - Push **hot air blower, Triac PID or Triac S (13)** into **holder for hot air blower (6)**.  
The hot air blower must be pushed in so that the distance between the end of the protective tube and **holder for hot air blower (6)** is 10 mm (see Detail A).
  - Tighten **fixing screw (14)**.
  - Push on **overlap welding nozzle (16)**.
- **Adjusting supporting carrier to the material thickness (Detail B).**
  - Loosen the **four fixing screws for supporting carrier (10)**.
  - Feed in a small section of the material to be welded between **drive unit (5)** and **double supporting carrier (8)** or **single supporting carrier (9)**.
  - Move **double supporting carrier (8)** or **single supporting carrier (9)** up to the material to be welded.
  - Tighten the **four fixing screws for supporting carrier (10)**.
  - Remove the material to be welded.
  - Check the previous setting (see Detail C).
- **Adjusting overlap welding nozzle (Detail D).**
  - Line up **overlap welding nozzle (16)** parallel to the **pressure roller (11)**.
  - Tighten **fixing screw for overlap welding nozzle (17)**.
  - Loosen the **adjusting screws for holder (7)**.
  - Line up the **overlap welding nozzle (16)** parallel to the material to be welded by moving the **hot air blower (13)** (Detail F). In order to avoid welding problems, the **double supporting carrier (8)** or **single supporting carrier (9)** and the pressure roller must be positioned together with the material being welded.
  - Tighten **adjusting screws for holder (7)**.

Detail A

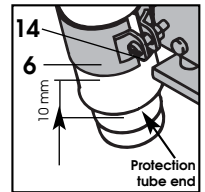

Detail B

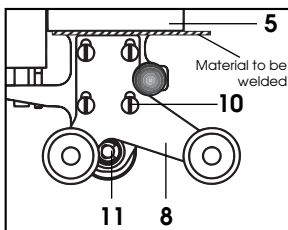

Detail C

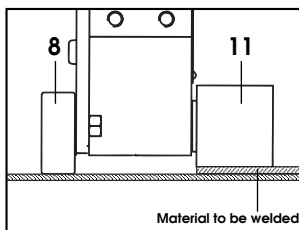

Detail D

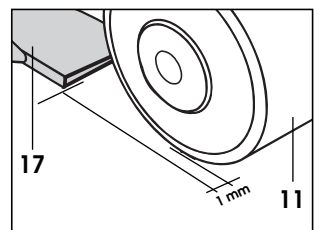

## Welding preparation

- Connect tool to the mains.
- Start up hot air blower LEISTER Triac PID or Triac S (see separate operating instructions):
  - Adjust temperature by means of potentiometer
  - Switch on mains switch
  - Warm up time approx. 5 min.

- **CAUTION:** Place TriacDrive in standby position on **tool storage bar (18)** (see picture). Use fireproof base.

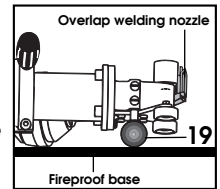

- **Mains switch (3) ON**

- Adjust the welding speed by means of **potentiometer (4)** depending on the foil or membrane and weather conditions.

## Test weld

- Position the overlap welding tool, LEISTER TriacDrive between the overlapped material to be welded and press downwards evenly by means of **handle (15)** or **drive unit (5)**. The welding process starts.
- Monitor the welding seam: welding bead/seam thickness reduction (Detail G). Adjust the welding speed by means of **potentiometer (4)** or the welding temperature (by means of potentiometer hot air blower) as required.

## Welding procedure

- **Pressure roller (11)** and **overlap welding nozzle (16)** must be clean before positioning the tool between the membrane or foil.
- Position the overlap welding nozzle between the overlapped membrane or foil (Detail F).
- Guide the tool at even pressure by means of the **handle (15)** and **drive unit (5)**. IMPORTANT: the **hot air blower (13)** is not to be used as a handle during the welding process!
- At the end of the welding process, take out the tool.
- Clean **overlap welding nozzle (16)** with a wire brush.
- Allow hot air blower to cool down.
- Switch off tool and disconnect from the mains.

Detail F

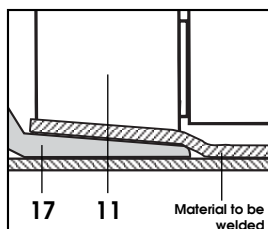

Detail G

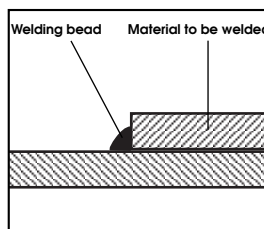

## ACCESSORIES

- Only LEISTER accessories should be used.
- Overlap welding nozzle
- Pressure roller
- Single supporting carrier, double supporting carrier
- Guide handle
- Hot air blower Triac PID
- Hot air blower Triac S

## TRAINING

- LEISTER Process Technologies and its authorised Service Centres offer free welding courses and training.

## MAINTENANCE

- Clean the **overlap welding nozzle (16)** with a wire brush.
- Check **mains cable (2)** and plug for electrical and mechanical damage.

## SERVICE AND REPAIR

- Have your Service Centre check the motor brushes after about 1,000 hours of operation.
- Repairs should only be carried out by authorised **LEISTER Service Centres**. They guarantee a correct and reliable **repair service within 24 hours** using original spare parts in accordance with the circuit diagrams and spare parts lists.

## GUARANTEE AND LIABILITY

- Guarantee and liability are in accordance with the guarantee certificate as well as with the currently valid general business and sales conditions.
- LEISTER Process Technologies rejects any guarantee claims for tools which are not in their original condition. The tools must never be altered or changed.

**Technical data and specifications are subject to change without prior notice.**

**Your authorized Service Centre is:**



## Service Record LEISTER

This document should be handed to the authorised LEISTER Service Center for updating when tool is repaired or serviced. This document is to be retained and kept by the owner of the tool.

### Technical Data

**Type** .....

**Order Number** .....

**Serial Number** .....

**Rated Voltage** ..... **V**

**Rated Power** ..... **W**

**Sold** ..... **Date**

### **Service**

1. Date ..... Service Centre ..... Signature .....

2. Date ..... Service Centre ..... Signature .....

3. Date ..... Service Centre ..... Signature .....

4. Date ..... Service Centre ..... Signature .....

5. Date ..... Service Centre ..... Signature .....

6. Date ..... Service Centre ..... Signature .....

### **Repair**

1. Date ..... Service Centre ..... Signature .....

2. Date ..... Service Centre ..... Signature .....

3. Date ..... Service Centre ..... Signature .....

